

- **Ideal for 418.00 MHz Transmitters**
- **Very Low Insertion Loss**
- **Quartz Stability**
- **Rugged, Hermetic, Low Profile TO-39 Package**

SR418

| Absolute Maximum Rating (Ta=25°C) | | | |
|-----------------------------------|-----------|-----------|------|
| Parameter | | Rating | Unit |
| CW RF Power Dissipation | P | 0 | dBm |
| DC Voltage | V_{DC} | ± 30 | V |
| Operating Temperature Range | T_A | -10 ~ +60 | °C |
| Storage Temperature Range | T_{stg} | -40 ~ +85 | °C |

| Electronic Characteristics | | | | | | |
|---|--------------------------------------|--------------|---------|---------|----------|---------------------|
| | Parameter | Sym | Minimum | Typical | Maximum | Unit |
| Frequency (25°C) | Nominal Frequency | f_C | NS | 418.00 | NS | MHz |
| | Tolerance from 418.00 MHz | Δf_C | - | - | ± 75 | KHz |
| Insertion Loss | | IL | - | 1.5 | 2.0 | dB |
| Quality Factor | Unloaded Q-Value | Q_U | - | 12,500 | - | - |
| | 50Ω Loaded Q-Value | Q_L | - | 2,000 | - | - |
| Temperature Stability | Turnover Temperature | T_O | 25 | - | 55 | °C |
| | Turnover Frequency | f_O | - | f_C | - | KHz |
| | Frequency Temperature Coefficient | FTC | - | -0.032 | - | ppm/°C ² |
| Frequency Aging | Absolute Value during the First Year | $ f_A $ | - | - | 10 | ppm/yr |
| DC Insulation Resistance Between any Two Pins | | - | 1.0 | - | - | MΩ |
| RF Equivalent RLC Model | Motional Resistance | R_M | - | 19.0 | 26.0 | Ω |
| | Motional Inductance | L_M | - | 90.6653 | - | μH |
| | Motional Capacitance | C_M | - | 1.5398 | - | fF |
| | Pin 1 to Pin 2 Static Capacitance | C_O | 1.7 | 2.0 | 2.3 | pF |

NS = Not Specified

Notes:

- The center frequency, f_C , is measured at the minimum IL point with the resonator in the 50Ω test system.
- Unless noted otherwise, case temperature $T_C = +25^\circ\text{C} \pm 2^\circ\text{C}$.
- Frequency aging is the change in f_C with time and is specified at +65°C or less. Aging may exceed the specification for prolonged temperatures above +65°C. Typically, aging is greatest the first year after manufacture, decreasing in subsequent years.
- Turnover temperature, T_O , is the temperature of maximum (or turnover) frequency, f_O . The nominal frequency at any case temperature, T_C , may be calculated from: $f = f_O [1 - FTC (T_O - T_C)^2]$.
- This equivalent RLC model approximates resonator performance near the resonant frequency and is provided for reference only. The capacitance C_O is the measured static (nonmotional) capacitance between Pin1 and Pin2. The measurement includes case parasitic capacitance.
- Derived mathematically from one or more of the following directly measured parameters: f_C , IL , 3 dB bandwidth, f_C versus T_C , and C_O .
- The specifications of this device are based on the test circuit shown above and subject to change or obsolescence without notice.
- Typically, equipment utilizing this device requires emissions testing and government approval, which is the responsibility of the equipment manufacturer.
- Our liability is only assumed for the Surface Acoustic Wave (SAW) component(s) per se, not for applications, processes and circuits implemented within components or assemblies.
- For questions on technology, prices and delivery please contact our sales offices or e-mail to sales@vanlong.com.

418.00 MHz One-Port SAW Resonator



Package Dimensions (TO-39)

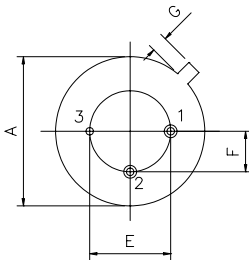
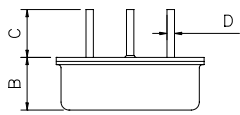

Electrical Connections

| Terminals | Connection |
|-----------|---------------|
| 1 | Input/ Output |
| 2 | Output/ Input |
| 3 | Case-Ground |

Package Dimensions

| Dimensions | Nom (mm) | |
|------------|--------------|-------|
| | Min | Max |
| A | 9.10 | 9.50 |
| B | 3.20 | 3.60 |
| C | 2.80 | 3.20 |
| D | Φ0.25 | Φ0.65 |
| E | 4.98 | 5.18 |
| F | 2.54 Nominal | |
| G | 0.4 | 0.5 |

Marking



Ink Marking
Color: Black or Blue

Equivalent LC Model and Test Circuit

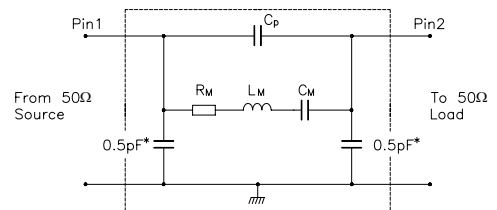

Typical Application Circuit

Low Power Transmitter Application

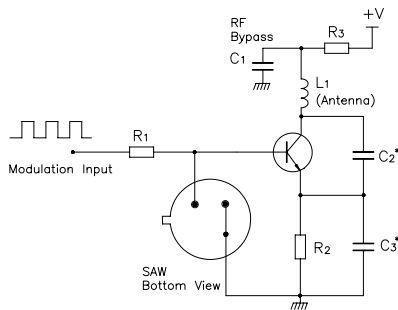

Local Oscillator Application

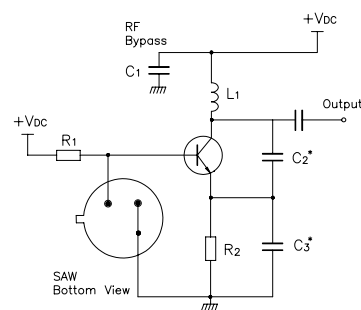

Typical Frequency Response

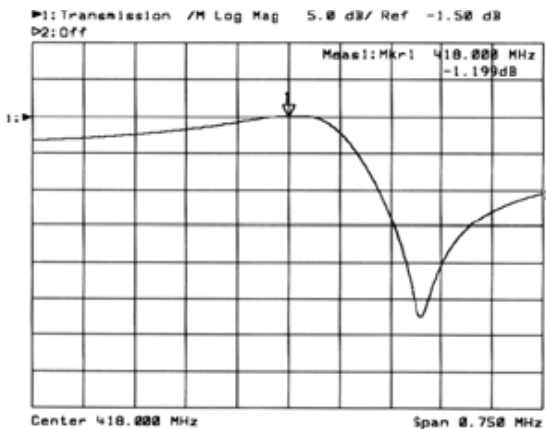

Temperature Characteristics

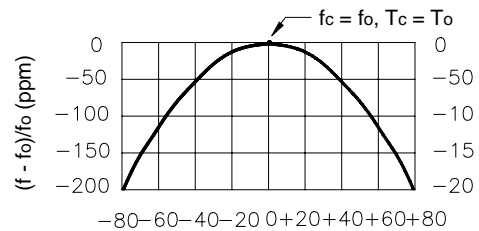

$$\Delta T = T_c - T_o \text{ (}^\circ\text{C)}$$

The curve shown above accounts for resonator contribution only and does not include oscillator temperature characteristics.